

### FEATURES

**3-axis sensing**

**Small, low profile package**

4 mm × 4 mm × 1.45 mm LFCSP

**Low power : 350  $\mu$ A (typical)**

**Single-supply operation: 1.8 V to 3.6 V**

**10,000 g shock survival**

**Excellent temperature stability**

**BW adjustment with a single capacitor per axis**

**RoHS/WEEE lead-free compliant**

### APPLICATIONS

**Cost sensitive, low power, motion- and tilt-sensing applications**

Mobile devices

Gaming systems

Disk drive protection

Image stabilization

Sports and health devices

### GENERAL DESCRIPTION

The ADXL335 is a small, thin, low power, complete 3-axis accelerometer with signal conditioned voltage outputs. The product measures acceleration with a minimum full-scale range of  $\pm 3 g$ . It can measure the static acceleration of gravity in tilt-sensing applications, as well as dynamic acceleration resulting from motion, shock, or vibration.

The user selects the bandwidth of the accelerometer using the  $C_X$ ,  $C_Y$ , and  $C_Z$  capacitors at the  $X_{OUT}$ ,  $Y_{OUT}$ , and  $Z_{OUT}$  pins. Bandwidths can be selected to suit the application, with a range of 0.5 Hz to 1600 Hz for the X and Y axes, and a range of 0.5 Hz to 550 Hz for the Z axis.

The ADXL335 is available in a small, low profile, 4 mm × 4 mm × 1.45 mm, 16-lead, plastic lead frame chip scale package (LFCSP\_LQ).

### FUNCTIONAL BLOCK DIAGRAM

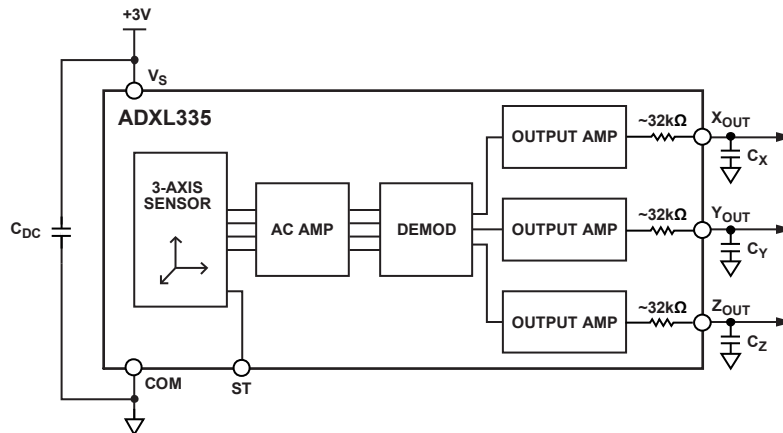

Figure 1.

### Rev. B

Information furnished by Analog Devices is believed to be accurate and reliable. However, no responsibility is assumed by Analog Devices for its use, nor for any infringements of patents or other rights of third parties that may result from its use. Specifications subject to change without notice. No license is granted by implication or otherwise under any patent or patent rights of Analog Devices. Trademarks and registered trademarks are the property of their respective owners.

## TABLE OF CONTENTS

Features .....	1	Performance .....	10
Applications.....	1	Applications Information .....	11
General Description .....	1	Power Supply Decoupling .....	11
Functional Block Diagram .....	1	Setting the Bandwidth Using $C_x$ , $C_y$ , and $C_z$ .....	11
Revision History .....	2	Self-Test .....	11
Specifications.....	3	Design Trade-Offs for Selecting Filter Characteristics: The Noise/BW Trade-Off.....	11
Absolute Maximum Ratings.....	4	Use with Operating Voltages Other Than 3 V .....	12
ESD Caution.....	4	Axes of Acceleration Sensitivity .....	12
Pin Configuration and Function Descriptions.....	5	Layout and Design Recommendations .....	13
Typical Performance Characteristics .....	6	Outline Dimensions .....	14
Theory of Operation .....	10	Ordering Guide .....	14
Mechanical Sensor.....	10		

## REVISION HISTORY

### 1/10—Rev. A to Rev. B

Changes to Figure 21 .....	9
----------------------------	---

### 7/09—Rev. 0 to Rev. A

Changes to Figure 22.....	9
Changes to Outline Dimensions.....	14

### 1/09—Revision 0: Initial Version

## SPECIFICATIONS

$T_A = 25^\circ\text{C}$ ,  $V_S = 3\text{ V}$ ,  $C_X = C_Y = C_Z = 0.1\ \mu\text{F}$ , acceleration = 0 g, unless otherwise noted. All minimum and maximum specifications are guaranteed. Typical specifications are not guaranteed.

Table 1.

Parameter	Conditions	Min	Typ	Max	Unit
SENSOR INPUT	Each axis				
Measurement Range		$\pm 3$	$\pm 3.6$		g
Nonlinearity	% of full scale		$\pm 0.3$		%
Package Alignment Error			$\pm 1$		Degrees
Interaxis Alignment Error			$\pm 0.1$		Degrees
Cross-Axis Sensitivity <sup>1</sup>			$\pm 1$		%
SENSITIVITY (RATIOMETRIC) <sup>2</sup>	Each axis				
Sensitivity at $X_{OUT}$ , $Y_{OUT}$ , $Z_{OUT}$	$V_S = 3\text{ V}$	270	300	330	mV/g
Sensitivity Change Due to Temperature <sup>3</sup>	$V_S = 3\text{ V}$		$\pm 0.01$		%/ $^\circ\text{C}$
ZERO g BIAS LEVEL (RATIOMETRIC)					
0 g Voltage at $X_{OUT}$ , $Y_{OUT}$	$V_S = 3\text{ V}$	1.35	1.5	1.65	V
0 g Voltage at $Z_{OUT}$	$V_S = 3\text{ V}$	1.2	1.5	1.8	V
0 g Offset vs. Temperature			$\pm 1$		mg/ $^\circ\text{C}$
NOISE PERFORMANCE					
Noise Density $X_{OUT}$ , $Y_{OUT}$			150		$\mu\text{g}/\sqrt{\text{Hz}}$ rms
Noise Density $Z_{OUT}$			300		$\mu\text{g}/\sqrt{\text{Hz}}$ rms
FREQUENCY RESPONSE <sup>4</sup>					
Bandwidth $X_{OUT}$ , $Y_{OUT}$ <sup>5</sup>	No external filter		1600		Hz
Bandwidth $Z_{OUT}$ <sup>5</sup>	No external filter		550		Hz
$R_{FILT}$ Tolerance			$32 \pm 15\%$		k $\Omega$
Sensor Resonant Frequency			5.5		kHz
SELF-TEST <sup>6</sup>					
Logic Input Low			+0.6		V
Logic Input High			+2.4		V
ST Actuation Current			+60		$\mu\text{A}$
Output Change at $X_{OUT}$	Self-Test 0 to Self-Test 1	-150	-325	-600	mV
Output Change at $Y_{OUT}$	Self-Test 0 to Self-Test 1	+150	+325	+600	mV
Output Change at $Z_{OUT}$	Self-Test 0 to Self-Test 1	+150	+550	+1000	mV
OUTPUT AMPLIFIER					
Output Swing Low	No load		0.1		V
Output Swing High	No load		2.8		V
POWER SUPPLY					
Operating Voltage Range		1.8		3.6	V
Supply Current	$V_S = 3\text{ V}$		350		$\mu\text{A}$
Turn-On Time <sup>7</sup>	No external filter		1		ms
TEMPERATURE					
Operating Temperature Range		-40		+85	$^\circ\text{C}$

<sup>1</sup> Defined as coupling between any two axes.

<sup>2</sup> Sensitivity is essentially ratiometric to  $V_S$ .

<sup>3</sup> Defined as the output change from ambient-to-maximum temperature or ambient-to-minimum temperature.

<sup>4</sup> Actual frequency response controlled by user-supplied external filter capacitors ( $C_X$ ,  $C_Y$ ,  $C_Z$ ).

<sup>5</sup> Bandwidth with external capacitors =  $1/(2 \times \pi \times 32\text{ k}\Omega \times C)$ . For  $C_X$ ,  $C_Y = 0.003\ \mu\text{F}$ , bandwidth = 1.6 kHz. For  $C_Z = 0.01\ \mu\text{F}$ , bandwidth = 500 Hz. For  $C_X$ ,  $C_Y$ ,  $C_Z = 10\ \mu\text{F}$ , bandwidth = 0.5 Hz.

<sup>6</sup> Self-test response changes cubically with  $V_S$ .

<sup>7</sup> Turn-on time is dependent on  $C_X$ ,  $C_Y$ ,  $C_Z$  and is approximately  $160 \times C_X$  or  $C_Y$  or  $C_Z + 1\text{ ms}$ , where  $C_X$ ,  $C_Y$ ,  $C_Z$  are in microfarads ( $\mu\text{F}$ ).

## ABSOLUTE MAXIMUM RATINGS

Table 2.

Parameter	Rating
Acceleration (Any Axis, Unpowered)	10,000 <i>g</i>
Acceleration (Any Axis, Powered)	10,000 <i>g</i>
$V_s$	-0.3 V to +3.6 V
All Other Pins	(COM - 0.3 V) to ( $V_s$ + 0.3 V)
Output Short-Circuit Duration (Any Pin to Common)	Indefinite
Temperature Range (Powered)	-55°C to +125°C
Temperature Range (Storage)	-65°C to +150°C

Stresses above those listed under Absolute Maximum Ratings may cause permanent damage to the device. This is a stress rating only; functional operation of the device at these or any other conditions above those indicated in the operational section of this specification is not implied. Exposure to absolute maximum rating conditions for extended periods may affect device reliability.

### ESD CAUTION



**ESD (electrostatic discharge) sensitive device.** Charged devices and circuit boards can discharge without detection. Although this product features patented or proprietary protection circuitry, damage may occur on devices subjected to high energy ESD. Therefore, proper ESD precautions should be taken to avoid performance degradation or loss of functionality.

## PIN CONFIGURATION AND FUNCTION DESCRIPTIONS

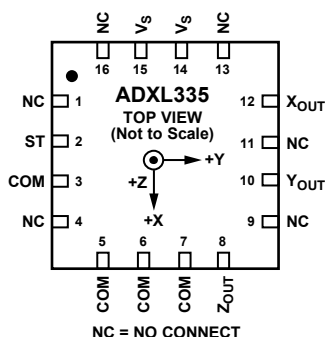

NOTES  
 1. EXPOSED PAD IS NOT INTERNALLY CONNECTED BUT SHOULD BE SOLDERED FOR MECHANICAL INTEGRITY.

077808-003

Figure 2. Pin Configuration

Table 3. Pin Function Descriptions

Pin No.	Mnemonic	Description
1	NC	No Connect. <sup>1</sup>
2	ST	Self-Test.
3	COM	Common.
4	NC	No Connect. <sup>1</sup>
5	COM	Common.
6	COM	Common.
7	COM	Common.
8	Z <sub>OUT</sub>	Z Channel Output.
9	NC	No Connect. <sup>1</sup>
10	Y <sub>OUT</sub>	Y Channel Output.
11	NC	No Connect. <sup>1</sup>
12	X <sub>OUT</sub>	X Channel Output.
13	NC	No Connect. <sup>1</sup>
14	V <sub>S</sub>	Supply Voltage (1.8 V to 3.6 V).
15	V <sub>S</sub>	Supply Voltage (1.8 V to 3.6 V).
16	NC	No Connect. <sup>1</sup>
EP	Exposed Pad	Not internally connected. Solder for mechanical integrity.

<sup>1</sup> NC pins are not internally connected and can be tied to COM pins, unless otherwise noted.

## TYPICAL PERFORMANCE CHARACTERISTICS

N > 1000 for all typical performance plots, unless otherwise noted.

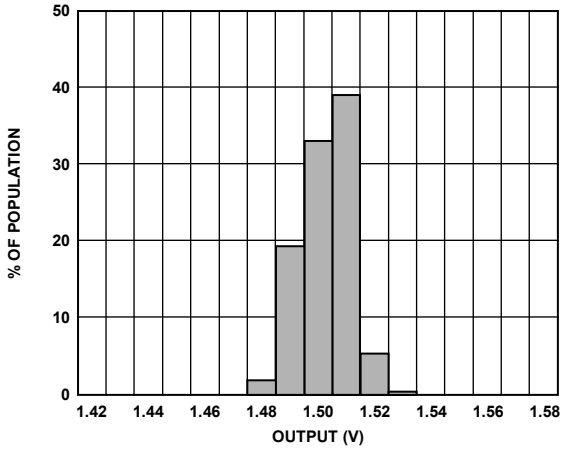

Figure 3. X-Axis Zero g Bias at 25°C,  $V_S = 3\text{ V}$

07808-005

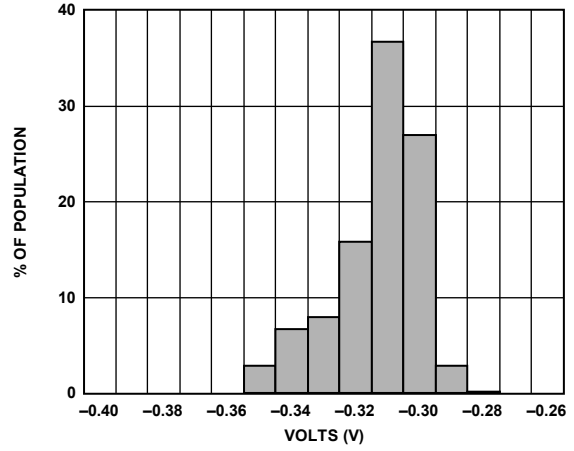

Figure 6. X-Axis Self-Test Response at 25°C,  $V_S = 3\text{ V}$

07808-008

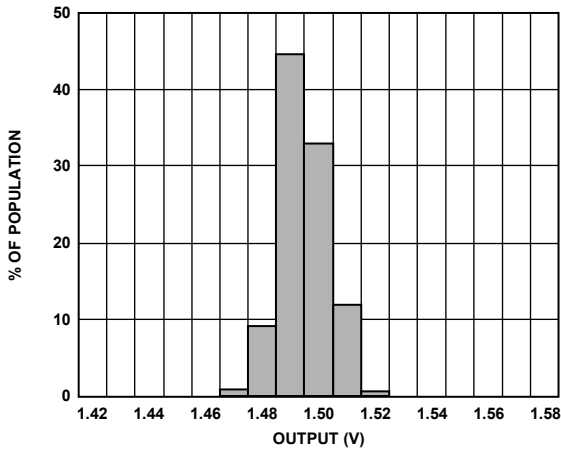

Figure 4. Y-Axis Zero g Bias at 25°C,  $V_S = 3\text{ V}$

07808-006

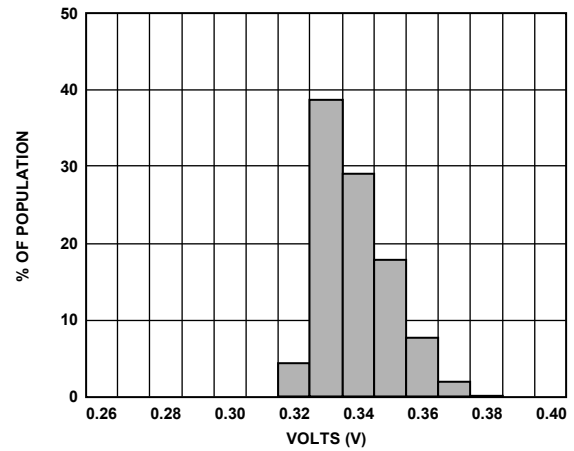

Figure 7. Y-Axis Self-Test Response at 25°C,  $V_S = 3\text{ V}$

07808-009

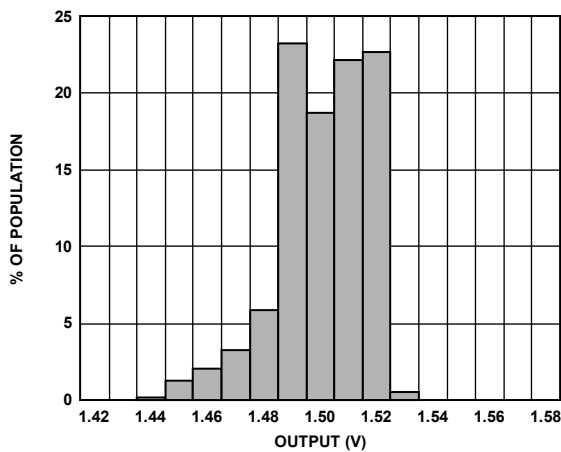

Figure 5. Z-Axis Zero g Bias at 25°C,  $V_S = 3\text{ V}$

07808-007

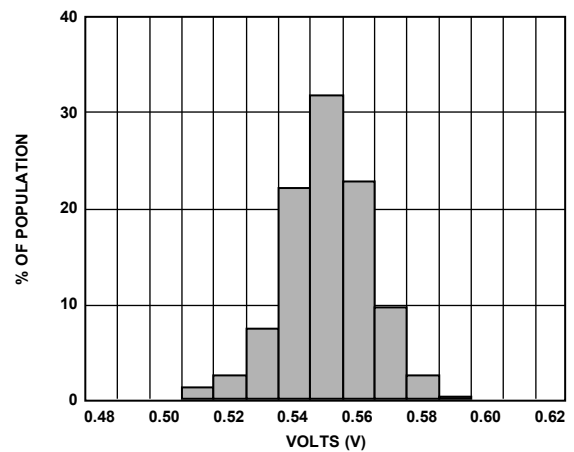

Figure 8. Z-Axis Self-Test Response at 25°C,  $V_S = 3\text{ V}$

07808-010

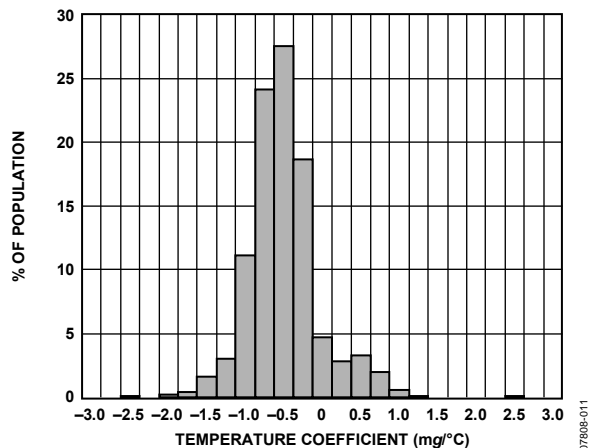

Figure 9. X-Axis Zero g Bias Temperature Coefficient,  $V_s = 3\text{ V}$

07808-011

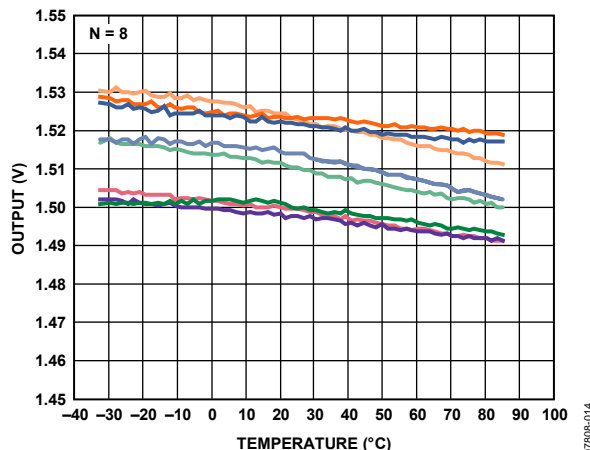

Figure 12. X-Axis Zero g Bias vs. Temperature—  
Eight Parts Soldered to PCB

07808-014

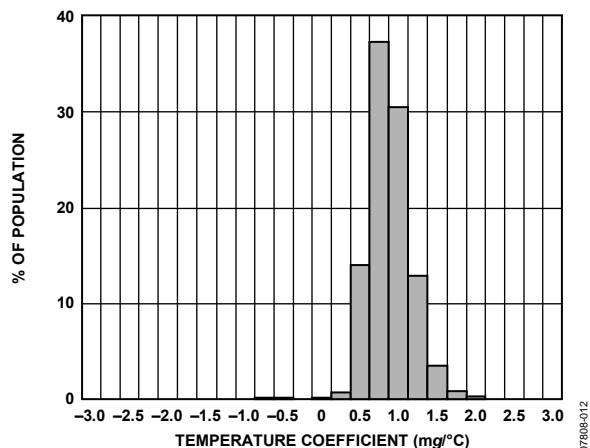

Figure 10. Y-Axis Zero g Bias Temperature Coefficient,  $V_s = 3\text{ V}$

07808-012

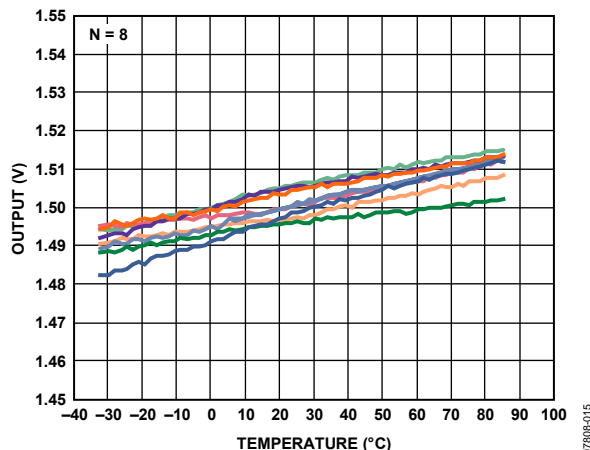

Figure 13. Y-Axis Zero g Bias vs. Temperature—  
Eight Parts Soldered to PCB

07808-015

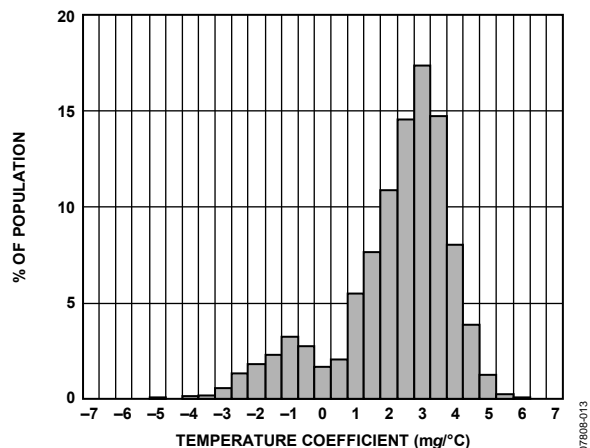

Figure 11. Z-Axis Zero g Bias Temperature Coefficient,  $V_s = 3\text{ V}$

07808-013

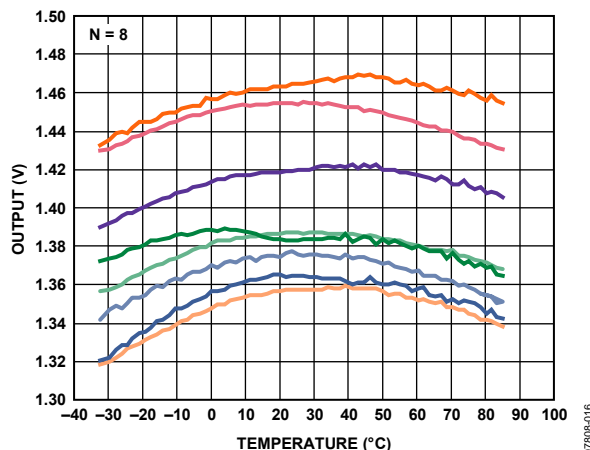

Figure 14. Z-Axis Zero g Bias vs. Temperature—  
Eight Parts Soldered to PCB

07808-016

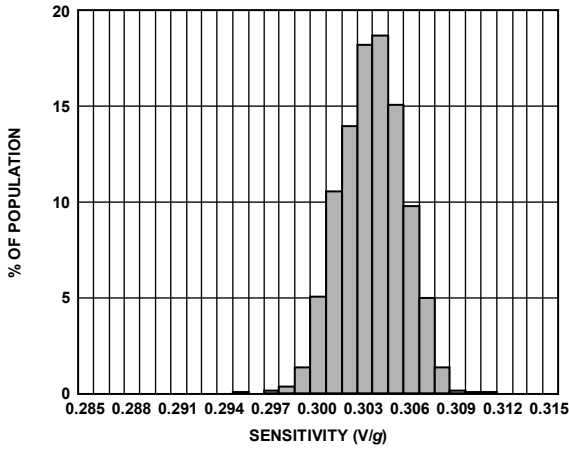

Figure 15. X-Axis Sensitivity at 25°C,  $V_S = 3\text{ V}$

07808-017

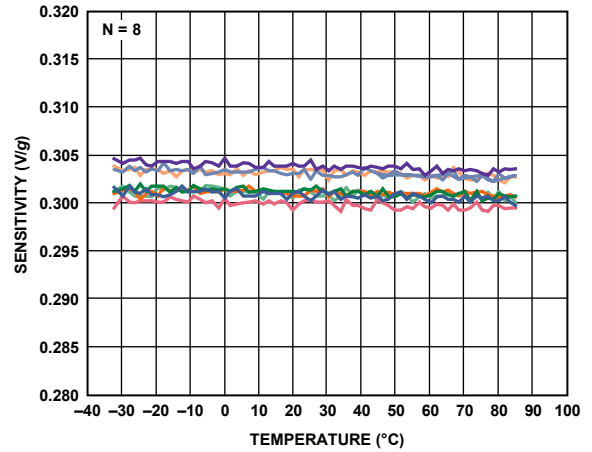

Figure 18. X-Axis Sensitivity vs. Temperature—  
Eight Parts Soldered to PCB,  $V_S = 3\text{ V}$

07808-020

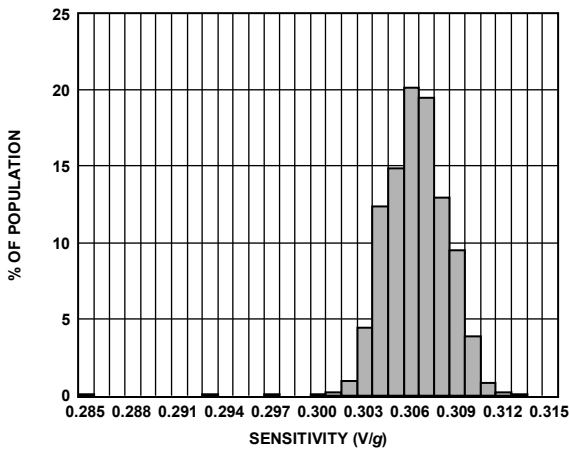

Figure 16. Y-Axis Sensitivity at 25°C,  $V_S = 3\text{ V}$

07808-018

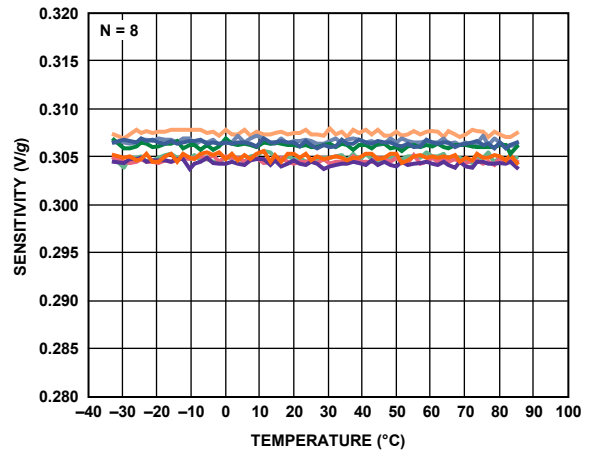

Figure 19. Y-Axis Sensitivity vs. Temperature—  
Eight Parts Soldered to PCB,  $V_S = 3\text{ V}$

07808-021

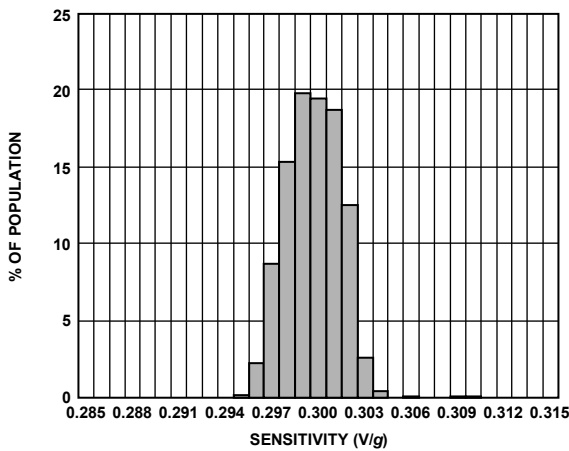

Figure 17. Z-Axis Sensitivity at 25°C,  $V_S = 3\text{ V}$

07808-019

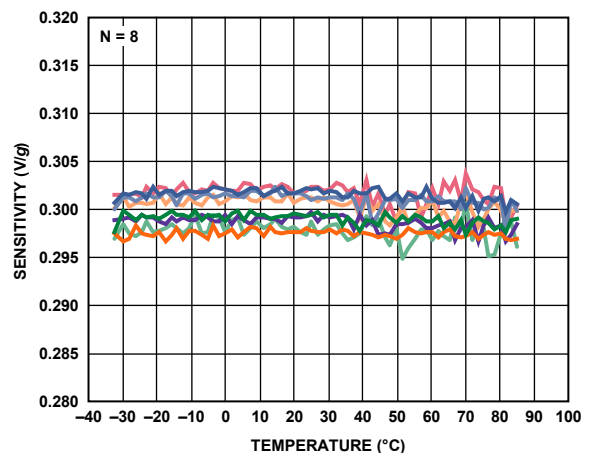

Figure 20. Z-Axis Sensitivity vs. Temperature—  
Eight Parts Soldered to PCB,  $V_S = 3\text{ V}$

07808-022



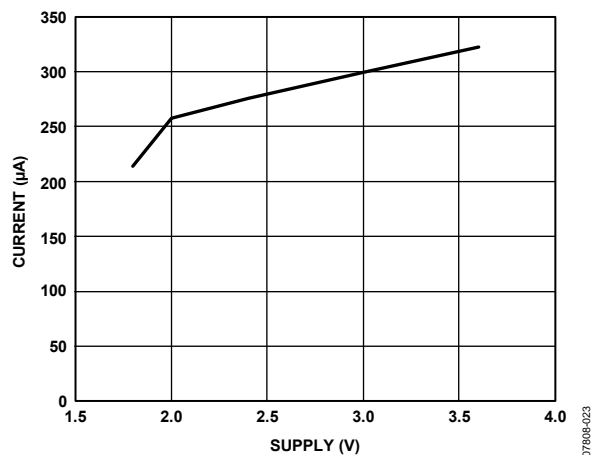

Figure 21. Typical Current Consumption vs. Supply Voltage

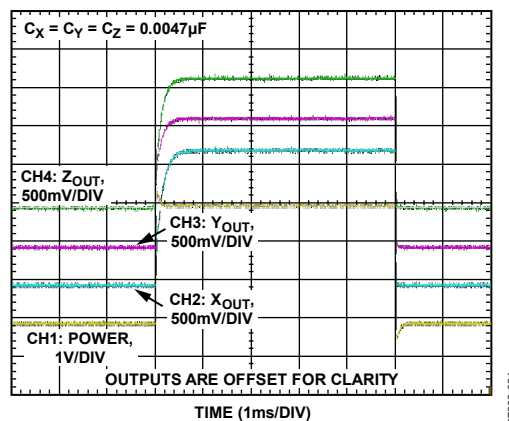

Figure 22. Typical Turn-On Time,  $V_s = 3V$

## THEORY OF OPERATION

The ADXL335 is a complete 3-axis acceleration measurement system. The ADXL335 has a measurement range of  $\pm 3$  g minimum. It contains a polysilicon surface-micromachined sensor and signal conditioning circuitry to implement an open-loop acceleration measurement architecture. The output signals are analog voltages that are proportional to acceleration. The accelerometer can measure the static acceleration of gravity in tilt-sensing applications as well as dynamic acceleration resulting from motion, shock, or vibration.

The sensor is a polysilicon surface-micromachined structure built on top of a silicon wafer. Polysilicon springs suspend the structure over the surface of the wafer and provide a resistance against acceleration forces. Deflection of the structure is measured using a differential capacitor that consists of independent fixed plates and plates attached to the moving mass. The fixed plates are driven by  $180^\circ$  out-of-phase square waves. Acceleration deflects the moving mass and unbalances the differential capacitor resulting in a sensor output whose amplitude is proportional to acceleration. Phase-sensitive demodulation techniques are then used to determine the magnitude and direction of the acceleration.

The demodulator output is amplified and brought off-chip through a  $32\text{ k}\Omega$  resistor. The user then sets the signal bandwidth of the device by adding a capacitor. This filtering improves measurement resolution and helps prevent aliasing.

### MECHANICAL SENSOR

The ADXL335 uses a single structure for sensing the X, Y, and Z axes. As a result, the three axes' sense directions are highly orthogonal and have little cross-axis sensitivity. Mechanical misalignment of the sensor die to the package is the chief source of cross-axis sensitivity. Mechanical misalignment can, of course, be calibrated out at the system level.

### PERFORMANCE

Rather than using additional temperature compensation circuitry, innovative design techniques ensure that high performance is built in to the ADXL335. As a result, there is no quantization error or nonmonotonic behavior, and temperature hysteresis is very low (typically less than  $3\text{ mg}$  over the  $-25^\circ\text{C}$  to  $+70^\circ\text{C}$  temperature range).

## APPLICATIONS INFORMATION

### POWER SUPPLY DECOUPLING

For most applications, a single 0.1  $\mu\text{F}$  capacitor,  $C_{\text{DC}}$ , placed close to the ADXL335 supply pins adequately decouples the accelerometer from noise on the power supply. However, in applications where noise is present at the 50 kHz internal clock frequency (or any harmonic thereof), additional care in power supply bypassing is required because this noise can cause errors in acceleration measurement.

If additional decoupling is needed, a 100  $\Omega$  (or smaller) resistor or ferrite bead can be inserted in the supply line. Additionally, a larger bulk bypass capacitor (1  $\mu\text{F}$  or greater) can be added in parallel to  $C_{\text{DC}}$ . Ensure that the connection from the ADXL335 ground to the power supply ground is low impedance because noise transmitted through ground has a similar effect to noise transmitted through  $V_{\text{S}}$ .

### SETTING THE BANDWIDTH USING $C_{\text{X}}$ , $C_{\text{Y}}$ , AND $C_{\text{Z}}$

The ADXL335 has provisions for band limiting the  $X_{\text{OUT}}$ ,  $Y_{\text{OUT}}$ , and  $Z_{\text{OUT}}$  pins. Capacitors must be added at these pins to implement low-pass filtering for antialiasing and noise reduction. The equation for the 3 dB bandwidth is

$$F_{-3\text{dB}} = 1/(2\pi(32\text{ k}\Omega) \times C_{(X,Y,Z)})$$

or more simply

$$F_{-3\text{dB}} = 5\ \mu\text{F}/C_{(X,Y,Z)}$$

The tolerance of the internal resistor ( $R_{\text{FILT}}$ ) typically varies as much as  $\pm 15\%$  of its nominal value (32 k $\Omega$ ), and the bandwidth varies accordingly. A minimum capacitance of 0.0047  $\mu\text{F}$  for  $C_{\text{X}}$ ,  $C_{\text{Y}}$ , and  $C_{\text{Z}}$  is recommended in all cases.

**Table 4. Filter Capacitor Selection,  $C_{\text{X}}$ ,  $C_{\text{Y}}$ , and  $C_{\text{Z}}$**

Bandwidth (Hz)	Capacitor ( $\mu\text{F}$ )
1	4.7
10	0.47
50	0.10
100	0.05
200	0.027
500	0.01

### SELF-TEST

The ST pin controls the self-test feature. When this pin is set to  $V_{\text{S}}$ , an electrostatic force is exerted on the accelerometer beam. The resulting movement of the beam allows the user to test if the accelerometer is functional. The typical change in output is  $-1.08\text{ g}$  (corresponding to  $-325\text{ mV}$ ) in the X-axis,  $+1.08\text{ g}$  (or  $+325\text{ mV}$ ) on the Y-axis, and  $+1.83\text{ g}$  (or  $+550\text{ mV}$ ) on the Z-axis. This ST pin can be left open-circuit or connected to common (COM) in normal use.

Never expose the ST pin to voltages greater than  $V_{\text{S}} + 0.3\text{ V}$ . If this cannot be guaranteed due to the system design (for instance, if there are multiple supply voltages), then a low  $V_{\text{F}}$  clamping diode between ST and  $V_{\text{S}}$  is recommended.

### DESIGN TRADE-OFFS FOR SELECTING FILTER CHARACTERISTICS: THE NOISE/BW TRADE-OFF

The selected accelerometer bandwidth ultimately determines the measurement resolution (smallest detectable acceleration). Filtering can be used to lower the noise floor to improve the resolution of the accelerometer. Resolution is dependent on the analog filter bandwidth at  $X_{\text{OUT}}$ ,  $Y_{\text{OUT}}$ , and  $Z_{\text{OUT}}$ .

The output of the ADXL335 has a typical bandwidth of greater than 500 Hz. The user must filter the signal at this point to limit aliasing errors. The analog bandwidth must be no more than half the analog-to-digital sampling frequency to minimize aliasing. The analog bandwidth can be further decreased to reduce noise and improve resolution.

The ADXL335 noise has the characteristics of white Gaussian noise, which contributes equally at all frequencies and is described in terms of  $\mu\text{g}/\sqrt{\text{Hz}}$  (the noise is proportional to the square root of the accelerometer bandwidth). The user should limit bandwidth to the lowest frequency needed by the application to maximize the resolution and dynamic range of the accelerometer.

With the single-pole, roll-off characteristic, the typical noise of the ADXL335 is determined by

$$\text{rms Noise} = \text{Noise Density} \times (\sqrt{BW \times 1.6})$$

It is often useful to know the peak value of the noise. Peak-to-peak noise can only be estimated by statistical methods. Table 5 is useful for estimating the probabilities of exceeding various peak values, given the rms value.

**Table 5. Estimation of Peak-to-Peak Noise**

Peak-to-Peak Value	% of Time That Noise Exceeds Nominal Peak-to-Peak Value
$2 \times \text{rms}$	32
$4 \times \text{rms}$	4.6
$6 \times \text{rms}$	0.27
$8 \times \text{rms}$	0.006

# ADXL335

## USE WITH OPERATING VOLTAGES OTHER THAN 3 V

The ADXL335 is tested and specified at  $V_S = 3\text{ V}$ ; however, it can be powered with  $V_S$  as low as 1.8 V or as high as 3.6 V. Note that some performance parameters change as the supply voltage is varied.

The ADXL335 output is ratiometric, therefore, the output sensitivity (or scale factor) varies proportionally to the supply voltage. At  $V_S = 3.6\text{ V}$ , the output sensitivity is typically 360 mV/g. At  $V_S = 2\text{ V}$ , the output sensitivity is typically 195 mV/g.

The zero g bias output is also ratiometric, thus the zero g output is nominally equal to  $V_S/2$  at all supply voltages.

The output noise is not ratiometric but is absolute in volts; therefore, the noise density decreases as the supply voltage increases. This is because the scale factor (mV/g) increases while the noise voltage remains constant. At  $V_S = 3.6\text{ V}$ , the X-axis and Y-axis noise density is typically  $120\text{ }\mu\text{g}/\sqrt{\text{Hz}}$ , whereas at  $V_S = 2\text{ V}$ , the X-axis and Y-axis noise density is typically  $270\text{ }\mu\text{g}/\sqrt{\text{Hz}}$ .

Self-test response in g is roughly proportional to the square of the supply voltage. However, when ratiometricity of sensitivity is factored in with supply voltage, the self-test response in volts is roughly proportional to the cube of the supply voltage. For example, at  $V_S = 3.6\text{ V}$ , the self-test response for the ADXL335 is approximately -560 mV for the X-axis, +560 mV for the Y-axis, and +950 mV for the Z-axis.

At  $V_S = 2\text{ V}$ , the self-test response is approximately -96 mV for the X-axis, +96 mV for the Y-axis, and -163 mV for the Z-axis.

The supply current decreases as the supply voltage decreases. Typical current consumption at  $V_S = 3.6\text{ V}$  is 375  $\mu\text{A}$ , and typical current consumption at  $V_S = 2\text{ V}$  is 200  $\mu\text{A}$ .

## AXES OF ACCELERATION SENSITIVITY

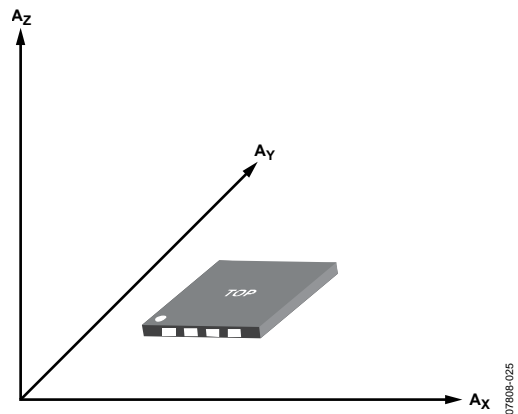

Figure 23. Axes of Acceleration Sensitivity; Corresponding Output Voltage Increases When Accelerated Along the Sensitive Axis.

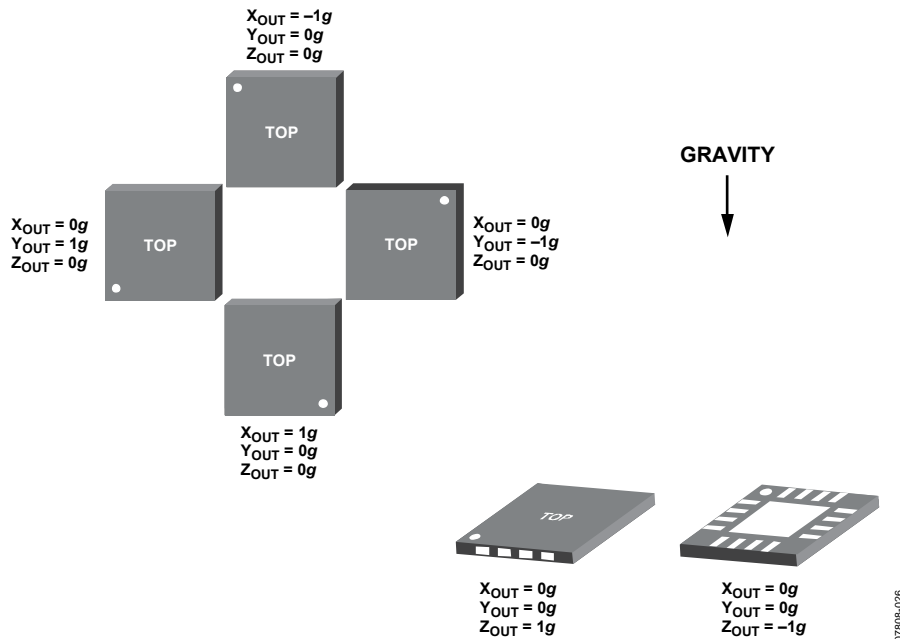

Figure 24. Output Response vs. Orientation to Gravity

**LAYOUT AND DESIGN RECOMMENDATIONS**

The recommended soldering profile is shown in Figure 25 followed by a description of the profile features in Table 6. The recommended PCB layout or solder land drawing is shown in Figure 26.

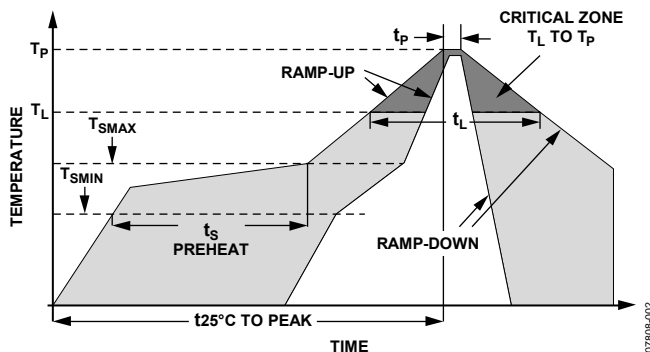

Figure 25. Recommended Soldering Profile

**Table 6. Recommended Soldering Profile**

Profile Feature	Sn63/Pb37	Pb-Free
Average Ramp Rate ( $T_L$ to $T_P$ )	3°C/sec max	3°C/sec max
Preheat		
Minimum Temperature ( $T_{SMIN}$ )	100°C	150°C
Maximum Temperature ( $T_{SMAX}$ )	150°C	200°C
Time ( $T_{SMIN}$ to $T_{SMAX}$ )( $t_s$ )	60 sec to 120 sec	60 sec to 180 sec
$T_{SMAX}$ to $T_L$		
Ramp-Up Rate	3°C/sec max	3°C/sec max
Time Maintained Above Liquidous ( $T_L$ )		
Liquidous Temperature ( $T_L$ )	183°C	217°C
Time ( $t_L$ )	60 sec to 150 sec	60 sec to 150 sec
Peak Temperature ( $T_P$ )	240°C + 0°C/-5°C	260°C + 0°C/-5°C
Time Within 5°C of Actual Peak Temperature ( $t_P$ )	10 sec to 30 sec	20 sec to 40 sec
Ramp-Down Rate	6°C/sec max	6°C/sec max
Time 25°C to Peak Temperature	6 minutes max	8 minutes max

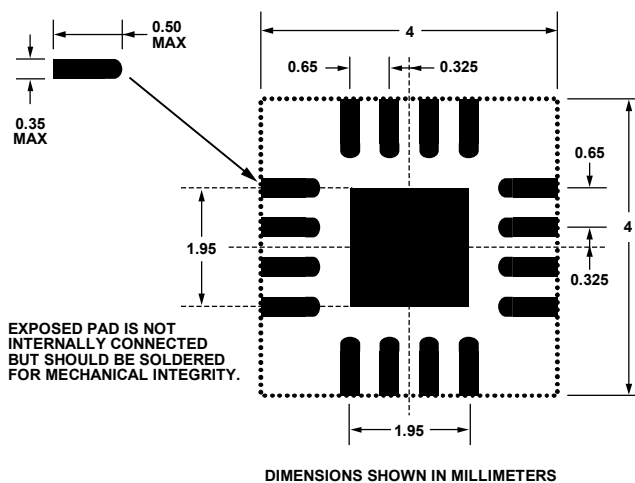
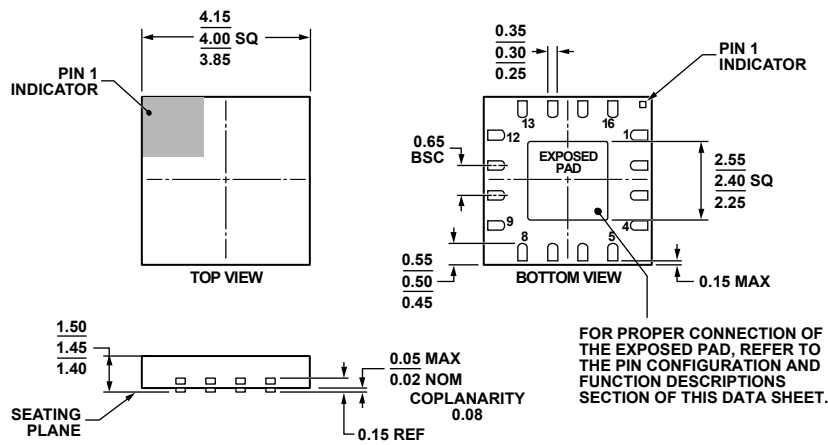

Figure 26. Recommended PCB Layout

# ADXL335

## OUTLINE DIMENSIONS



COMPLIANT TO JEDEC STANDARDS MO-220-WGGD.

Figure 27. 16-Lead Lead Frame Chip Scale Package [LFCSP\_LQ]  
 4 mm × 4 mm Body, 1.45 mm Thick Quad  
 (CP-16-14)  
 Dimensions shown in millimeters

051902-A

## ORDERING GUIDE

Model <sup>1</sup>	Measurement Range	Specified Voltage	Temperature Range	Package Description	Package Option
ADXL335BCPZ	±3 g	3 V	-40°C to +85°C	16-Lead LFCSP_LQ	CP-16-14
ADXL335BCPZ-RL	±3 g	3 V	-40°C to +85°C	16-Lead LFCSP_LQ	CP-16-14
ADXL335BCPZ-RL7	±3 g	3 V	-40°C to +85°C	16-Lead LFCSP_LQ	CP-16-14
EVAL-ADXL335Z				Evaluation Board	

<sup>1</sup> Z = RoHS Compliant Part.

**NOTES**

**ADXL335**

## NOTES

Analog Devices offers specific products designated for automotive applications; please consult your local Analog Devices sales representative for details. Standard products sold by Analog Devices are not designed, intended, or approved for use in life support, implantable medical devices, transportation, nuclear, safety, or other equipment where malfunction of the product can reasonably be expected to result in personal injury, death, severe property damage, or severe environmental harm. Buyer uses or sells standard products for use in the above critical applications at Buyer's own risk and Buyer agrees to defend, indemnify, and hold harmless Analog Devices from any and all damages, claims, suits, or expenses resulting from such unintended use.

©2009–2010 Analog Devices, Inc. All rights reserved. Trademarks and registered trademarks are the property of their respective owners.  
D07808-0-1/10(B)



[www.analog.com](http://www.analog.com)



# Mouser Electronics

Authorized Distributor

Click to View Pricing, Inventory, Delivery & Lifecycle Information:

[Analog Devices Inc.:](#)

[EVAL-ADXL335Z](#) [ADXL335BCPZ](#) [ADXL335BCPZ-RL7](#) [ADXL335BCPZ-RL](#)