

Title: <i>EXP Micro ZED</i>		 <b>NTB INTERSTAATLICHE HOCHSCHULE FÜR TECHNIK BUCHS</b>
Description: <i>Übersicht</i>		
Name: <i>MÜLM</i>	Checked: *	
Size: <i>A4</i>	Number: *	Revision: <i>1.1</i>
Date: <i>15.09.2020</i>	Time: <i>08:48:58</i>	Sheet * of *
File: <i>D:\07_PlayGround\MicroZED\B2_EXP_MicroZED\A1_EXP_MicroZED.SchDoc</i>		
		<i>NTB Interstate University of Applied Sciences of Technology Buchs Werdenbergstrasse 4 9471 Buchs Switzerland</i>

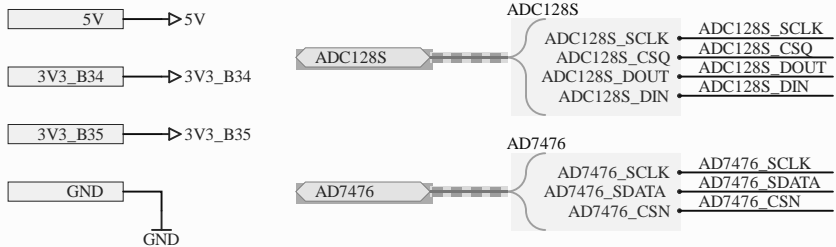

JX1

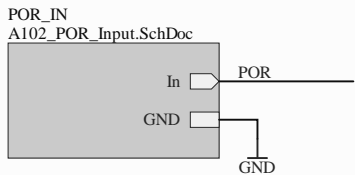
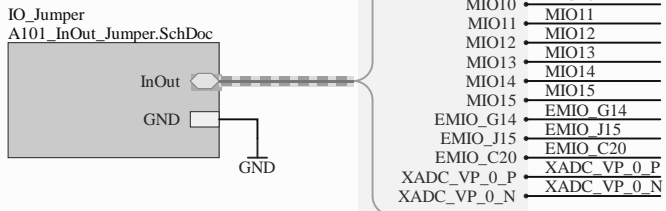
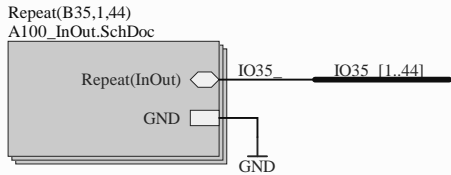
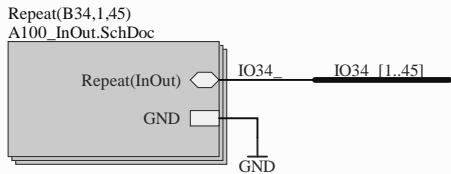
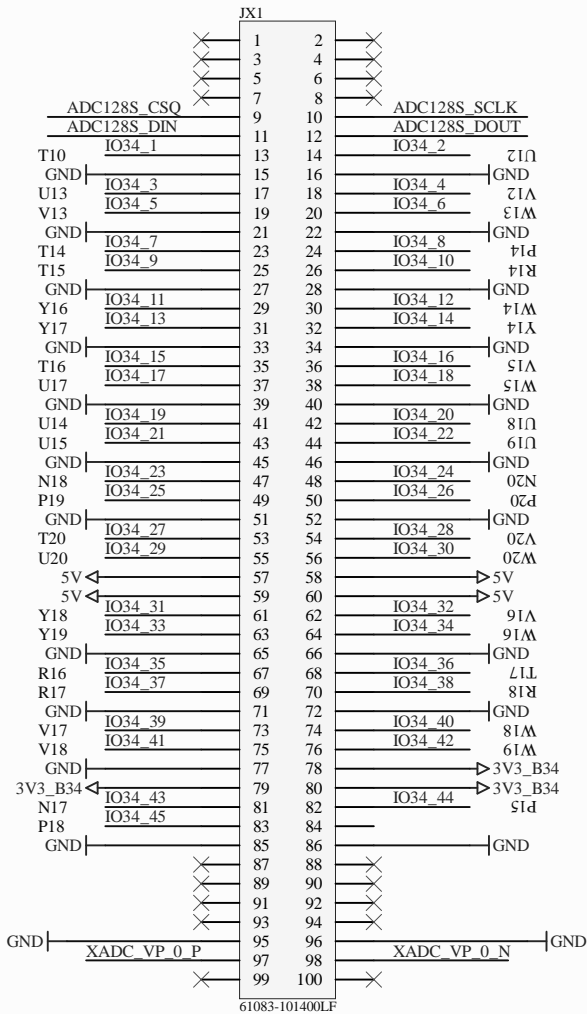

JX2

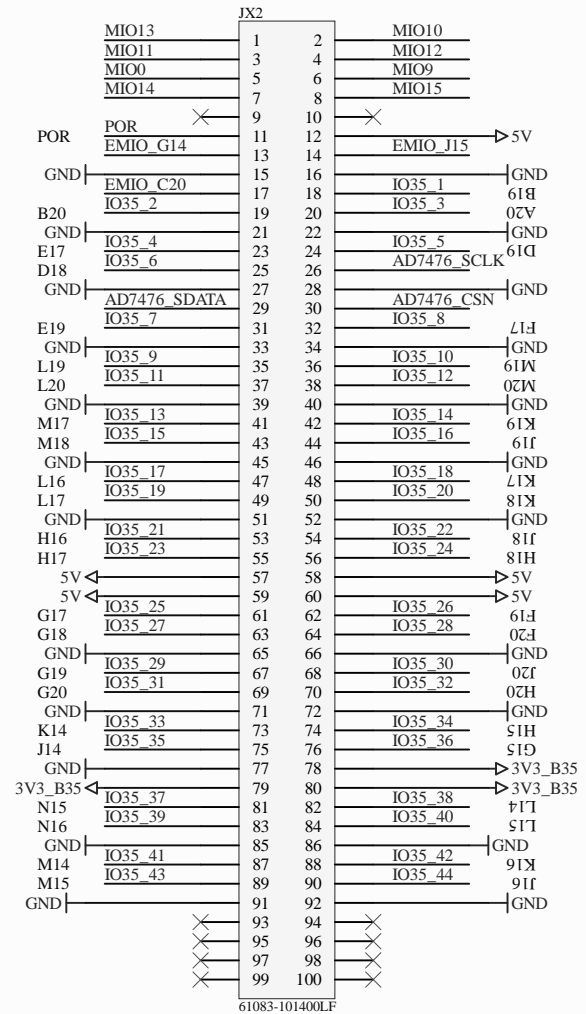

Title: EXP Micro ZED		NTB INTERSTAATLICHE HOCHSCHULE FÜR TECHNIK BUCHS	
Description: Micro ZED			
Name: MÜLM	Checked: *	NTB Interstate University of Applied Sciences of Technology Buchs Werdenbergstrasse 4 9471 Buchs Switzerland	
Size: A4	Number: *		Revision: 1.1
Date: 15.09.2020	Time: 08:48:58		Sheet * of *
File: D:\07_PlayGround\MicroZED\B2_EXP_MicroZED\A10_MicroZED.SchDoc			

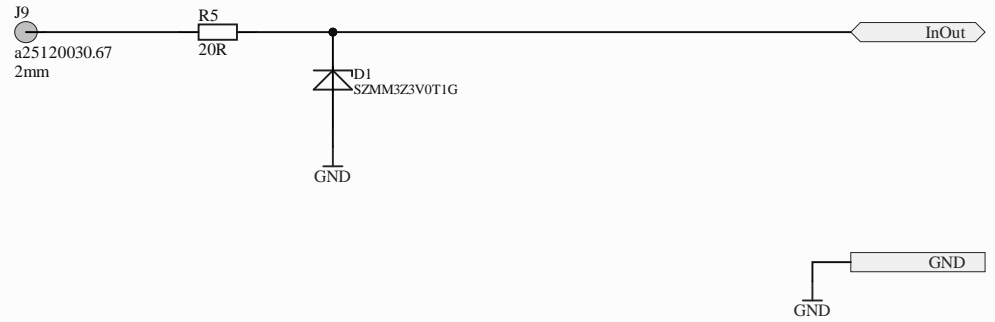

Title: <i>EXP Micro ZED</i>			 <b>NTB INTERSTAATLICHE HOCHSCHULE FÜR TECHNIK BUCHS</b>	
Description: <i>Allgemeine I/Os</i>				
Name: <i>MÜLM</i>		Checked: *		<i>NTB Interstate University of Applied Sciences of Technology Buchs Werdenbergstrasse 4 9471 Buchs Switzerland</i>
Size: <i>A4</i>	Number: *	Revision: <i>1.1</i>		
Date: <i>15.09.2020</i>	Time: <i>08:48:58</i>	Sheet * of *		
File: <i>D:\07_PlayGround\MicroZED\B2_EXP_MicroZED\A100_InOut.SchDoc</i>				

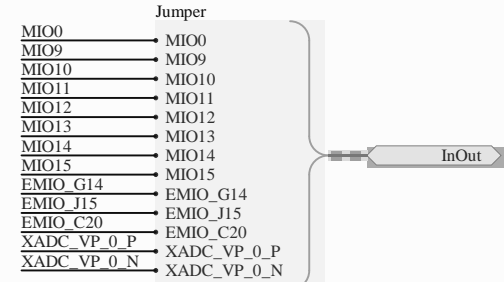
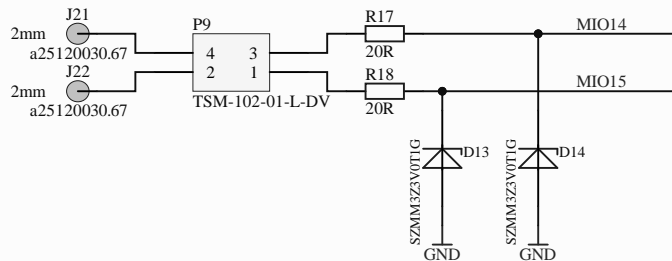
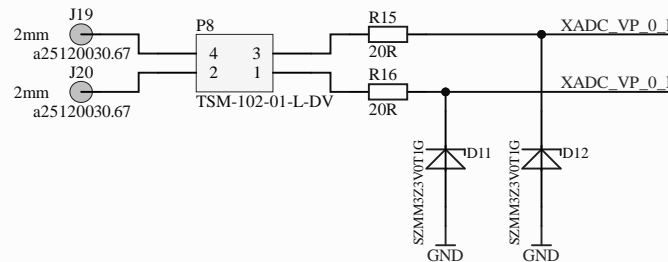
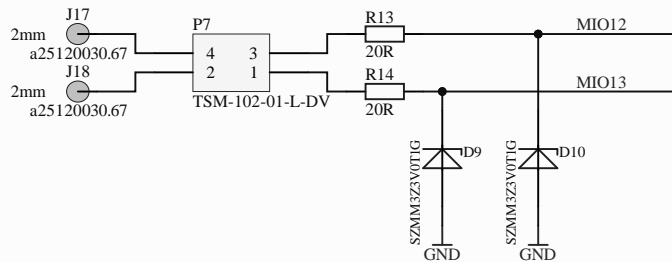
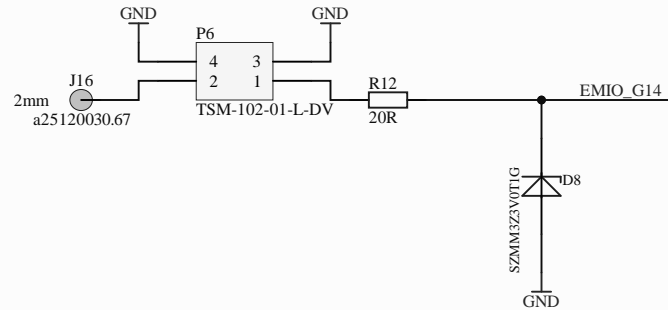
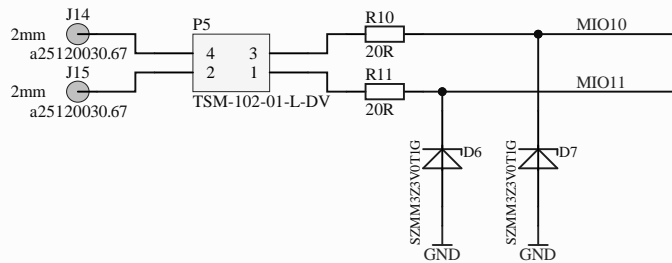
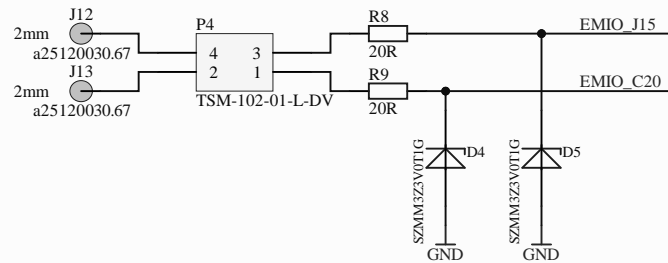
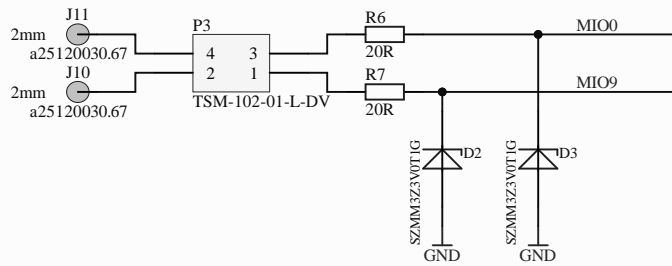

Title: <i>EXP Micro ZED</i>		 <b>NTB</b> INTERSTAATLICHE HOCHSCHULE FÜR TECHNİK BUCHS	
Description: <i>I/Os mit Jumper</i>			
Name: <i>MÜLM</i>	Checked: *	<i>NTB Interstate University of Applied          Sciences of Technology Buchs          Werdenbergstrasse 4          9471 Buchs Switzerland</i>	
Size: <i>A4</i>	Number: *		Revision: <i>1.1</i>
Date: <i>15.09.2020</i>	Time: <i>08:48:58</i>		Sheet * of *
File: <i>D:\07_PlayGround\MicroZED\B2_EXP_MicroZED\A101_InOut_Jumper.SchDoc</i>			



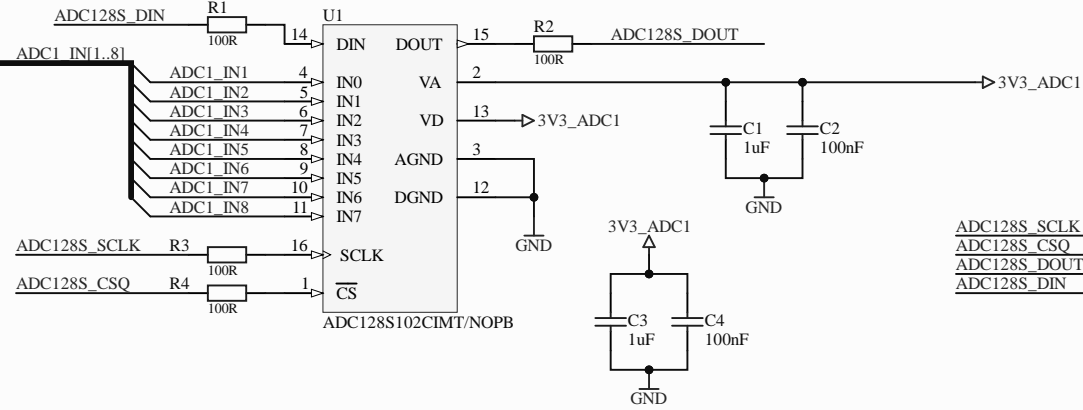
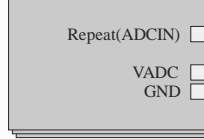

Title: <i>EXP Micro ZED</i>			 <b>NTB INTERSTAATLICHE HOCHSCHULE FÜR TECHNIK BUCHS</b>  <i>NTB Interstate University of Applied Sciences of Technology Buchs Werdenbergstrasse 4 9471 Buchs Switzerland</i>
Description: <i>POR</i>			
Name: <i>MÜLM</i>	Checked: *		
Size: <i>A4</i>	Number: *	Revision: <i>1.1</i>	
Date: <i>15.09.2020</i>	Time: <i>08:48:58</i>	Sheet * of *	
File: <i>D:\07_PlayGround\MicroZED\B2_EXP_MicroZED\A102_POR_Input.SchDoc</i>			

Repeat(A,1,8)  
A110\_ADC\_Input.SchDoc



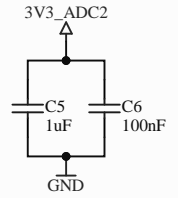
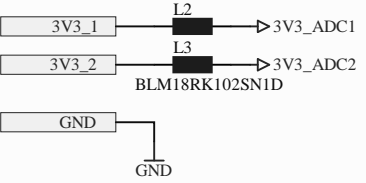
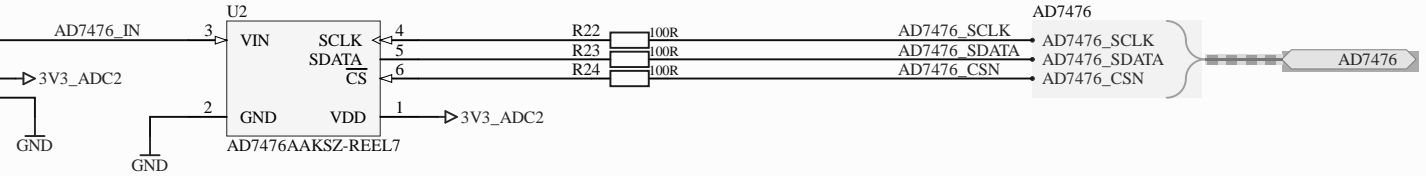
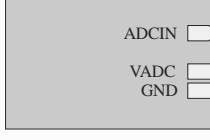

AD7476  
A110\_ADC\_Input.SchDoc

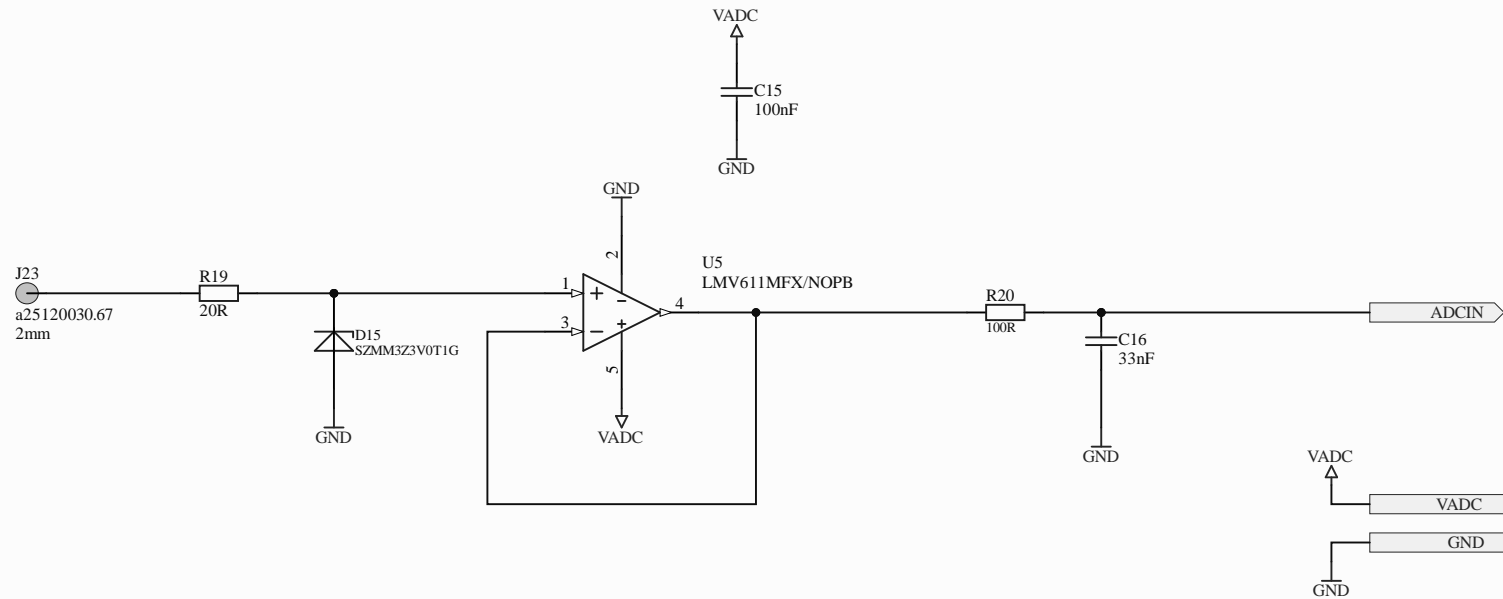

Title: EXP Micro ZED		 <b>NTB</b> INTERSTAATLICHE HOCHSCHULE FÜR TECHNIK BUCHS
Description: ADC Übersicht		
Name: MÜLM	Checked: *	
Size: A4	Number: *	Revision: 1.1
Date: 15.09.2020	Time: 08:48:58	Sheet * of *
File: D:\07_PlayGround\MicroZED\B2_EXP_MicroZED\A11_ADC.SchDoc		

NTB Interstate University of Applied Sciences of Technology Buchs  
Werdenbergstrasse 4  
9471 Buchs Switzerland



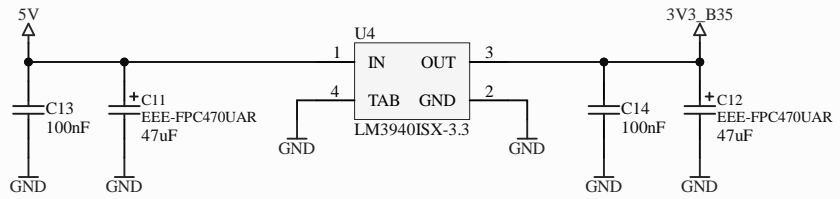
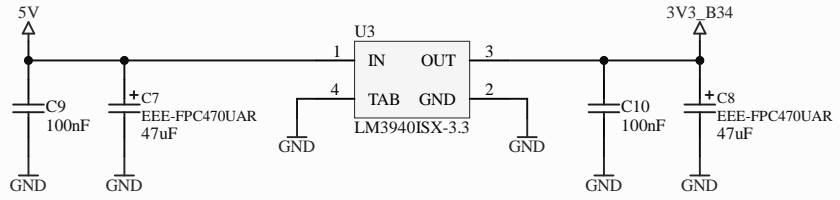

Title: <i>EXP Micro ZED</i>		 <b>NTB</b> <b>INTERSTAATLICHE HOCHSCHULE</b> <b>FÜR TECHNIK BUCHS</b>
Description: <i>ADC Inputs</i>		
Name: <i>MÜLM</i>	Checked: *	
Size: <i>A4</i>	Number: *	Revision: <i>1.1</i>
Date: <i>15.09.2020</i>	Time: <i>08:48:58</i>	Sheet * of *
File: <i>D:\07_PlayGround\MicroZED\B2_EXP_MicroZED\A110_ADC_Input.SchDoc</i>		
		<b>NTB Interstate University of Applied</b> <b>Sciences of Technology Buchs</b> <i>Werdenbergstrasse 4</i> <i>9471 Buchs Switzerland</i>

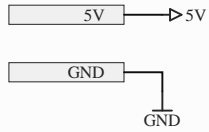

3V3\_B34 ← 3V3\_B34

3V3\_B35 ← 3V3\_B35



Title: EXP Micro ZED			 <b>NTB</b> INTERSTAATLICHE HOCHSCHULE FÜR TECHNIK BUCHS
Description: Spannungsversorgung			
Name: MÜLM	Checked: *		NTB Interstate University of Applied Sciences of Technology Buchs Werdenbergstrasse 4 9471 Buchs Switzerland
Size: A4	Number: *	Revision: 1.1	
Date: 15.09.2020	Time: 08:48:58	Sheet * of *	
File: D:\07_PlayGround\MicroZED\B2_EXP_MicroZED\A12_Spannungsversorgung.SchDoc			



# EXP\_MicroZED

ESA Repository: \10707\_NTB\_SYSP\trunk\EXP\_MicroZED

Roadmap betreffend PCB Erstellung:

Es gilt der HW Entwicklungsprozess des Instituts ESA.

- |                                   |              |
|-----------------------------------|--------------|
| 1. Anforderungsliste              | Checkmark    |
| 2. Blockschema                    | Laszlo Arato |
| 3. Blockschema Review durchführen | Max Muster   |
| 4. Schema                         | Max Muster   |
| 5. Schema Review durchführen      | Marco Müller |
| 6. PCB Layout                     | Laszlo Arato |
| 7. PCB Layout Review durchführen  | Marco Müller |
|                                   | Max Muster   |
- 

Links zu Dokumenten:

[HW Entwicklungsprozess Institut ESA](#)

[Einführung Altium Designer](#)

[Checkliste für die Leiterplattenproduktion](#)

[Technische Infos Layout und Leiterplatte](#)

[Vorlagen unter diesem SVN Link](#)

[Altium Vorlagen unter diesem SVN Link](#)

PCB Hersteller:  
PCB Hersteller Design Rules:

PCB Bestücker:  
PCB Bestücker Design Rules:

Spannungsbereiche:

Strombereiche:

Massekonzept:

Layer Stack PCB:

Normen:

Notizen:

Title: EXP Micro ZED		 NTB INTERSTAATLICHE HOCHSCHULE FÜR TECHNIK BUCHS	
Description: Allgemeine Informationen zu Schema und Layout			
Name: *		Checked: GRAR	
Size: A4	Number: *	Revision: 1.1	
Date: 15.09.2020	Time: 08:48:58	Sheet * of *	
File: D:\07_PlayGround\MicroZED\B2_EXP_MicroZED\InfoBlatt.SchDoc			
		NTB Interstate University of Applied Sciences of Technology Buchs Werdenbergstrasse 4 9471 Buchs Switzerland	